

5/8" PROFILES

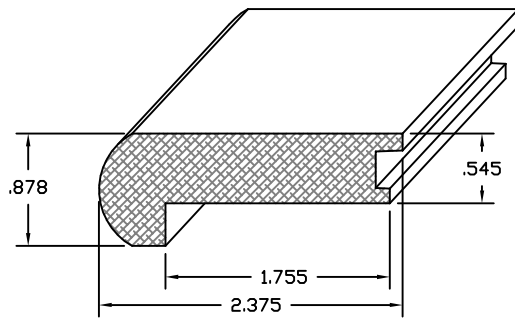

DWG #707
STAIRNOSE

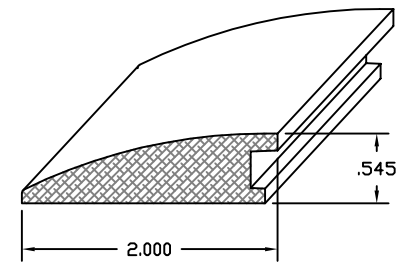

DWG #706
REDUCER

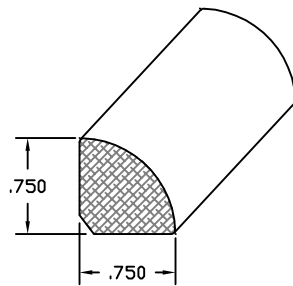

DWG #45
QUARTER ROUND

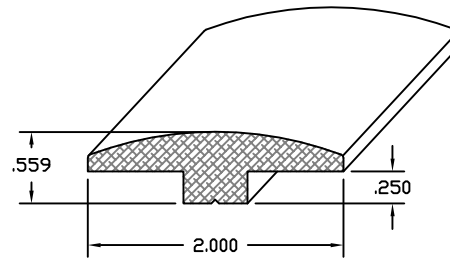

DWG #473
T-MOLDING

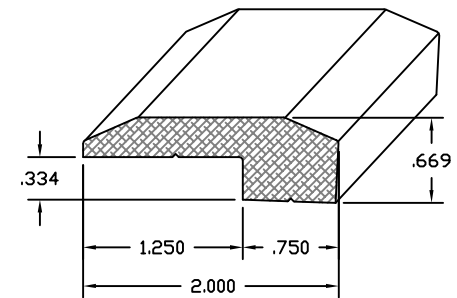

DWG #474
THRESHOLD