

3/8" PROFILES

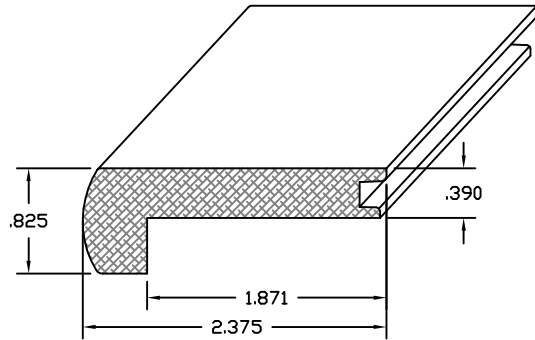

DWG # 700
STAIRNOSE

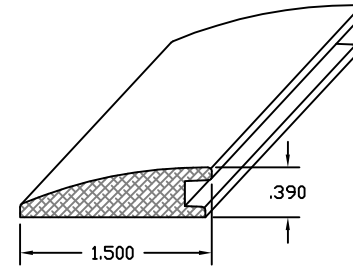

DWG # 701
REDUCER

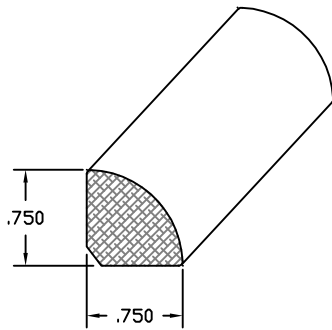

DWG #45
QUARTER ROUND

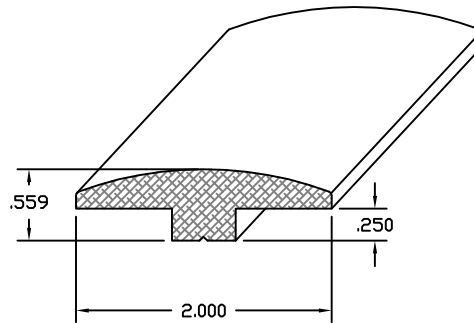

DWG #473
T-MOLDING

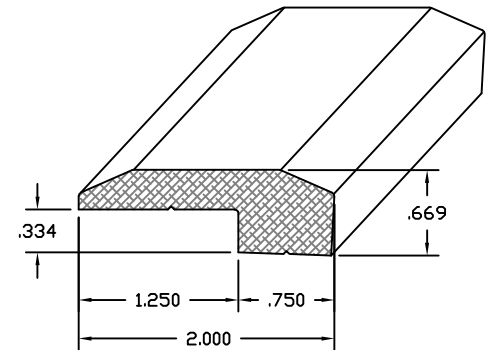

DWG #474
THRESHOLD